



EDITION PRO Termostato de ducha para montaje a pared - Cromo

34 442 626



- Rosetas corredizas Ø 70 mm
- Calibración 150 mm ± 13 mm
- Inversor giratorio con llave de paso
- Salida ducha de 3/8"
- Con regulación de caudal

Protección contra reflujo.

	Cromo	34 442 626-00
	Negro mate	34 442 626-33
	Cromo cepillado	34 442 626-93

EDITION PRO Termostato de ducha para montaje a pared - Cromo

34 442 626

mm [inches]



Diagrama de flujo



Certificado

Belgaqua_21-384- 27_5. LGA_29986. WRAS_2204005.

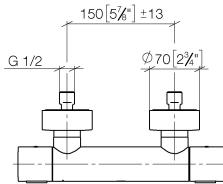
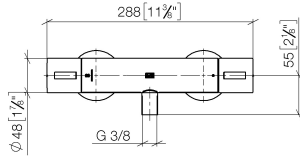
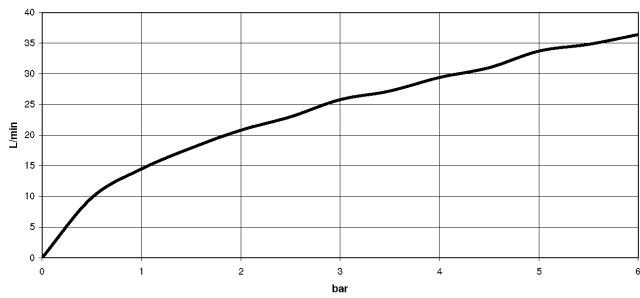
EDITION PRO Termostato de ducha para montaje a pared - Cromo

34 442 626

Piezas para otros acabados pueden encontrarse aquí:
Negro mate

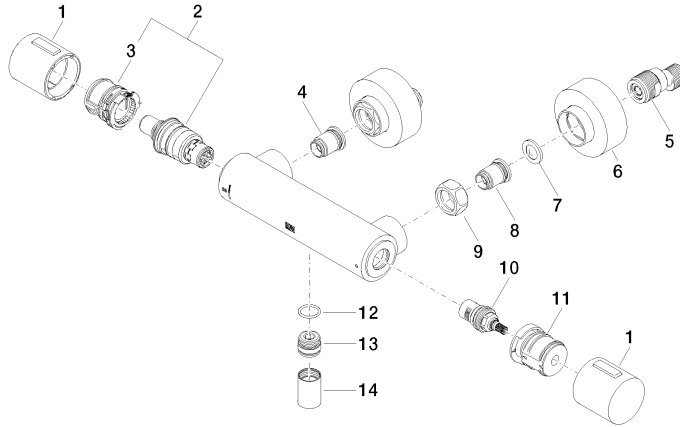

Lista de piezas de recambios

N°	Número de artículo	Denominación	Cantidad de montaje	Plazo de entrega
1	90 17 33 015 00-00	manilla	2	10
2	90 15 02 070 00 90	cartucho	1	2
3	90 30 40 010 00 90	regulador	1	2
4	04 31 20 530 00 90	elemento insertable	1	2
5	04 11 04 030 00 90	racor	2	2
6	90 31 20 512 00-00	roseta	2	2
7	09 29 30 050 90	tamiz	2	2
8	04 31 20 540 00 90	elemento insertable	1	2
9	09 24 77 008-00	tuerca	2	10
10	90 90 03 236 00 90	parte superior	1	2
11	90 30 40 017 00 90	alojamiento	1	2
12	90 14 10 010 00 90	sello	1	2
13	09 31 20 511-00	boquilla	1	10
14	90 21 02 069 00-00	funda	1	10